

QX HAWK

Embedded Ethernet & Ultra-Lock Connectors



C-Mount Option



Flexible, Industrial Imager for Auto ID

The QX Hawk is the world's first imager to be fully integrated with liquid lens technology, enabling infinite focus flexibility. Bridging the gap between ease of use and performance, the QX Hawk features optional C-mount lens design, a high resolution modular optical zoom system, aggressive X-Mode decoding, and simple plug and play connectivity. The QX Hawk imager easily reads any barcode or 2D symbol, including challenging 2D direct part marks (DPM), in any environment, within seconds of installation.

QX Hawk: At a Glance

- Decodes/Second: Up to 60
- Read Range: Varies by Configuration
- Liquid Lens Autofocus & Modular Zoom
- Optional C-Mount Lens Model Available
- Integrated Ethernet Networking
- Configuration Options: 0.4MP CMOS or 1.3MP CCD



ESP® Easy Setup Program: Single-point software solution provides quick and easy setup and configuration of all Microscan readers.



EZ Button: This performs reader setup and configuration with no computer required.



Visible Indicators: Performance indicators include "good read" green flash and LEDs.



QX Platform: Provides simple connectivity, networking, and high performance decoding.

For more information on this product, visit www.microscan.com.

QX Hawk: Available Codes

Linear	All Standard	Postal Codes	
Stacked	MicroPDF	PDF417	GS1 Databar
	Data Matrix	QR	Micro QR
2D			

Decode Any Symbol

Using best-in-class X-Mode decode algorithms, the QX Hawk consistently captures everything from low contrast, damaged, or otherwise challenging direct part marks, to a high density 3.3 mil Data Matrix, to a very large linear barcode.

Powerful Performance

The QX Hawk is powered by a dual core ARM/DSP processor to allow both high speed image capture and real time configuration and communication. The embedded processing, combined with three high speed inputs/outputs directly from the reader, enable the QX Hawk to provide line level control functions.

Ease of Use

In addition to a compact size for flexible positioning, the QX Hawk includes visible LED indicators, targeting laser pattern, "good read" green flash, and an EZ button for instant setup and configuration.

Advanced Optical System

The integrated optics design includes a high resolution modular optical zoom system that enables the QX Hawk to read marks at distances from 20 mm to 800 mm and beyond. Combined with patented liquid lens autofocus, the QX Hawk can easily cover almost any auto ID application.

Ethernet Protocols

Integrated Ethernet protocols are included for high speed communication.

Rugged Design

The QX Hawk features a rugged industrial design with a cast alloy IP65/67 enclosure and M12 connectors.

Application Examples

- Printed circuit boards
- Electronics and semiconductor manufacturing
- Automotive
- Aerospace
- Medical devices

MICROSCAN®

QX HAWK FLEXIBLE, INDUSTRIAL IMAGER

SPECIFICATIONS AND OPTIONS

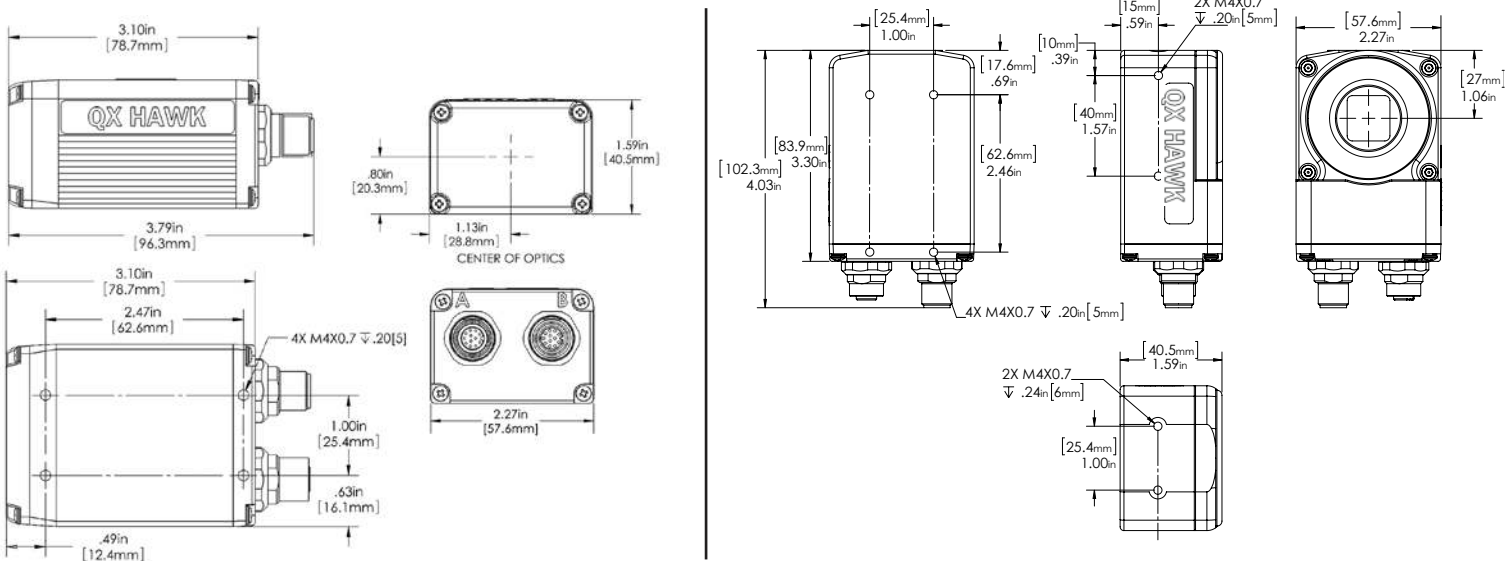

NOTE: Nominal dimensions shown. Typical tolerances apply. For Integrated Optics Model Read Range charts and information, see Page 3.

MECHANICAL (INTEGRATED OPTICS)

Height: 1.59" (40.5 mm)
Width: 2.27" (57.6 mm)
Depth: 3.79" (96.3 mm)
Weight: 10 oz. (280 g)

MECHANICAL (C-MOUNT OPTICS)

Height: 4.03" (102.3 mm)
Width: 2.27" (57.6 mm)
Depth: 1.59" (40.5 mm)
Weight: 11 oz. (320 g)

ENVIRONMENTAL

Enclosure: Die-cast aluminum, IP65/67 rated
CMOS Operating Temperature: 0° to 50° C (32° to 122° F)
CCD Operating Temperature: 0° to 45° C (32° to 113° F)
Storage Temperature: -29° to 70° C (-20° to 158° F)
Humidity: Up to 90% (non-condensing)

COMMUNICATION INTERFACE

Interface: RS-232/422/485 or Ethernet

CE MARK

General Immunity for Light Industry:
 EN 55024: 1998 ITE Immunity Standard
Radiated and Conducted Emissions of ITE Equipment: EN 55022:98 ITE Disturbances

LIGHT SOURCE (INTEGRATED OPTICS)

Type: High output LEDs



SYMBOLOGIES

2D Symbologies: Data Matrix (ECC 0-200), QR Code, Micro QR Code, Aztec Code
Stacked Symbologies: PDF417, Micro PDF417, GS1 Databar (Composite & Stacked)
Linear Barcodes: Code 39, Code 128, BC 412, I2 of 5, UPC/EAN, Codabar, Code 93, Pharmacomde, PLANET, PostNet, Japanese Post, Australian Post, Royal Mail, Intelligent Mail, KIX

LIGHT COLLECTION OPTIONS

Progressive scan, square pixel.
Shutter: Software adjustable 10 μs to 1/60 second
Sensor: 1/3 inch
WVGA: CMOS, 752 by 480 pixels, up to 60 fps
SXGA: CCD, 1280 by 960 pixels, up to 20 fps

PIN ASSIGNMENTS CONNECTOR A

M12 12-pin plug:

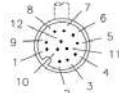

Pin Assignment
9 Host RxD
10 Host TxD
2 Power
7 Ground
1 Trigger
8 Input Common
3 Default
4 New Master
5 Output 1
11 Output 2
6 Output 3
12 Output Common

CONNECTOR B

M12 12-pin socket:



Pin Assignment
9 TxD/RTS
10 RxD/CTS
2 Power
7 Ground
1 Trigger
8 Input Common
3 Terminated
4 Input 1
5 422/485 TxD (+)
11 422/485 TxD (-)
6 422/485 RxD (+)
12 422/485 RxD (-)

ETHERNET CONFIGURATION CONNECTOR B

M12 8-pin socket:

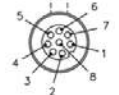

Pin Assignment
1 Terminated
2 Terminated
3 Terminated
4 TX (-)
5 RX (+)
6 TX (+)
7 Terminated
8 RX (-)

INDICATORS

LEDS: Read Performance, Power, Read Status, Network activity, I/O **Beeper:** Good read, match/mismatch, no/read, serial command confirmation, on/off

INTEGRATED OPTICS MODEL ONLY:

Green Flash: Good read **Red X:** Symbol locator

READ PARAMETERS

Pitch: ±30° **Skew:** ±30° **Tilt:** 360°
CMOS Decode Rate: Up to 60 decodes per second
CCD Decode Rate: Up to 20 decodes per second

LASER LIGHT (INTEGRATED OPTICS)

Type: Laser diode
Output Wavelength: 655 nm nominal
Operating Life: 50,000 hours @ 25° C
Safety Class: Visible laser: Class 1

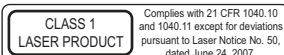

PROTOCOLS

Point-to-Point, Point-to-Point w/RTS/CTS, Point-to-Point w/XON/XOFF, Point-to-Point w/RTS/CTS & XON/XOFF, Multidrop, Daisy Chain, User-Defined Multidrop, Ethernet TCP/IP, EtherNet/IP

ELECTRICAL

CMOS Power Requirement: 5-28 VDC, 200 mV p-p max ripple, 135 mA at 24 VDC (typ.)
CCD Power Requirement: 5-28 VDC, 200 mV p-p max ripple, 170 mA at 24 VDC (typ.)

DISCRETE I/O

Input 1/Trigger/New Master: Bi-directional, optoisolated, 4.5-28V rated, (13 mA at 24 VDC)
Outputs (1, 2 & 3): Bi-directional, optoisolated, 1-28V rated, (I_{CE} <100 mA at 24 VDC, current limited by user)

SAFETY CERTIFICATIONS

CDRH, FCC, UL/cUL, CE, CB, BSMI (compliant)

ROHS/WEEE COMPLIANT

ISO CERTIFICATION

Certified ISO 9001:2008 Quality Management System

©2015 Microscan Systems, Inc. SP064J-EN-1113
 Read Range and other performance data is determined using high quality Grade A symbols per ISO/IEC 15415 and ISO/IEC 15416 in a 25° C environment. For application-specific Read Range results, testing should be performed with symbols used in the actual application. Microscan Applications Engineering is available to assist with evaluations. Results may vary depending on symbol quality. **Warranty**—For current warranty information on this product, please visit www.microscan.com/warranty.

MICROSCAN®

Microscan Systems Inc.

Tel 425 226 5700 / 800 251 7711

Fax 425 226 8250

Microscan Europe

Tel 31 172 423360 / Fax 31 172 423366

Microscan Asia Pacific

Tel 65 6846 1214 / Fax 65 6846 4641

www.microscan.com

Product Information: info@microscan.com

Technical Support: helpdesk@microscan.com

QX HAWK FLEXIBLE, INDUSTRIAL IMAGER

SPECIFICATIONS AND OPTIONS

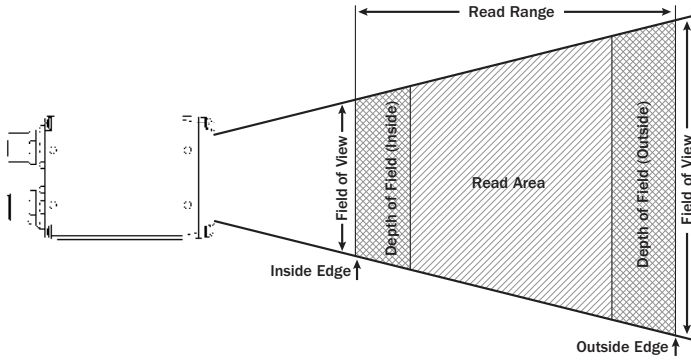



INTEGRATED OPTICS MODEL: CMOS MODULAR ZOOM OPTICS

Inches (mm)

12°	Narrow-bar-width		Read Range (using autofocus)	Field of View		Depth of Field	
	1D	2D		Inside Edge	Outside Edge	Inside Edge	Outside Edge
	0.0033 (0.08)	0.005 (0.13)	3.4 to 6 (86 to 152)	0.9 (23)	1.42 (36)	0.2 (5)	0.4 (10)
	0.0075 (0.19)	0.010 (0.25)	3.3 to 12.2 (83 to 310)	0.9 (23)	2.62 (66)	0.4 (10)	1.5 (38)
	0.0150 (0.38)	0.020 (0.51)	3.3 to 13 (82 to 330)	0.9 (23)	2.77 (70)	0.5 (13)	3.5 (89)
	0.0350 (0.89)	0.050 (1.27)	4 to 16 (101 to 406)	1.03 (26)	3.34 (85)	0.7 (18)	6.5 (165)

15°	Narrow-bar-width		Read Range (using autofocus)	Field of View		Depth of Field	
	1D	2D		At Inside Edge	At Outside Edge	Inside Edge	Outside Edge
	0.0033 (0.08)	0.005 (0.13)	1.9 to 5 (48 to 127)	0.75 (19)	1.53 (39)	0.3 (6)	0.4 (10)
	0.0075 (0.19)	0.010 (0.25)	1.8 to 8 (46 to 203)	0.72 (18)	2.28 (58)	0.4 (10)	1 (25)
	0.0150 (0.38)	0.020 (0.51)	1.75 to 9 (44 to 229)	0.72 (18)	2.52 (64)	0.5 (13)	3 (76)
	0.0350 (0.89)	0.050 (1.27)	3 to 10.8 (76 to 274)	1.03 (26)	2.96 (75)	0.6 (15)	4 (101)

30°	Narrow-bar-width		Read Range (using autofocus)	Field of View		Depth of Field	
	1D	2D		Inside Edge	Outside Edge	Inside Edge	Outside Edge
	0.0033 (0.08)	0.005 (0.13)	1 to 3 (25 to 76)	0.83 (21)	1.8 (46)	0.4 (10)	0.8 (20)
	0.0075 (0.19)	0.010 (0.25)	1 to 6.5 (25 to 165)	0.83 (21)	3.5 (89)	0.8 (20)	1.8 (46)
	0.0150 (0.38)	0.020 (0.51)	1 to 16 (25 to 406)	0.83 (21)	8.3 (211)	2 (51)	8.5 (216)
	0.0350 (0.89)	0.050 (1.27)	2 to 32 (51 to 813)	1.3 (33)	16.4 (417)	3 (76)	21.5 (546)

45°	Narrow-bar-width		Read Range (using autofocus)	Field of View		Depth of Field	
	1D	2D		Inside Edge	Outside Edge	Inside Edge	Outside Edge
	0.0075 (0.19)	0.010 (0.25)	1 to 5 (25 to 127)	1.3 (33)	4.1 (104)	1.5 (38)	2 (51)
	0.0150 (0.38)	0.020 (0.51)	1 to 9.5 (25 to 241)	1.3 (33)	7.5 (191)	2 (51)	6 (152)
	0.0350 (0.89)	0.050 (1.27)	1 to 23.5 (25 to 597)	1.3 (33)	18.3 (465)	3.8 (97)	19 (483)

NOTE: Read ranges are for specific element sizes as listed in the tables.

INTEGRATED OPTICS MODEL: CCD MODULAR ZOOM OPTICS

Inches (mm)

12°	Narrow-bar-width		Read Range (using autofocus)	Field of View		Depth of Field	
	1D	2D		Inside Edge	Outside Edge	Inside Edge	Outside Edge
	0.002 (0.05)	0.0033 (0.08)	3.5 to 7 (87 to 178)	0.9 (23)	1.62 (41)	0.1 (3)	0.3 (8)
	0.005 (0.13)	0.0075 (0.19)	3.4 to 12 (86 to 304)	0.9 (23)	2.62 (66)	0.2 (5)	1 (25)
	0.010 (0.25)	0.0150 (0.38)	3.3 to 13 (83 to 330)	0.9 (23)	2.77 (70)	0.4 (10)	2.5 (64)
	0.020 (0.51)	0.0300 (0.76)	4 to 14 (101 to 355)	1.03 (26)	2.96 (75)	0.6 (15)	5 (127)

15°	Narrow-bar-width		Read Range (using autofocus)	Field of View		Depth of Field	
	1D	2D		At Inside Edge	At Outside Edge	Inside Edge	Outside Edge
	0.002 (0.05)	0.0033 (0.08)	2 to 5 (51 to 127)	0.78 (20)	1.53 (39)	0.2 (5)	0.4 (10)
	0.005 (0.13)	0.0075 (0.19)	1.9 to 8.3 (48 to 210)	0.75 (19)	2.35 (60)	0.3 (8)	1 (25)
	0.010 (0.25)	0.0150 (0.38)	1.9 to 9.5 (47 to 241)	0.75 (19)	2.65 (67)	0.5 (13)	3 (76)
	0.020 (0.51)	0.0300 (0.76)	3 to 10.3 (76 to 261)	1.03 (26)	2.84 (72)	0.6 (15)	4.5 (114)

30°	Narrow-bar-width		Read Range (using autofocus)	Field of View		Depth of Field	
	1D	2D		Inside Edge	Outside Edge	Inside Edge	Outside Edge
	0.002 (0.05)	0.0033 (0.08)	1 to 3 (25 to 76)	0.83 (21)	1.8 (46)	0.4 (10)	0.8 (20)
	0.005 (0.13)	0.0075 (0.19)	1 to 6.5 (25 to 165)	0.83 (21)	3.5 (89)	0.8 (20)	1.8 (46)
	0.010 (0.25)	0.0150 (0.38)	1 to 16 (25 to 406)	0.83 (21)	8.3 (211)	2 (51)	8.5 (216)
	0.020 (0.51)	0.0300 (0.76)	2 to 32 (51 to 813)	1.3 (33)	16.4 (417)	3 (76)	21.5 (546)

45°	Narrow-bar-width		Read Range (using autofocus)	Field of View		Depth of Field	
	1D	2D		Inside Edge	Outside Edge	Inside Edge	Outside Edge
	0.005 (0.13)	0.0075 (0.19)	1 to 5 (25 to 127)	1.3 (33)	4.1 (104)	1.5 (38)	2 (51)
	0.010 (0.25)	0.0150 (0.38)	1 to 9.5 (25 to 241)	1.3 (33)	7.5 (191)	2 (51)	6 (152)
	0.020 (0.51)	0.0300 (0.76)	1 to 23.5 (25 to 597)	1.3 (33)	18.3 (465)	3.8 (97)	19 (483)

NOTE: Read ranges are for specific element sizes as listed in the tables.