



Small
 Powerful
 Agile
 Intuitive
Simply Incredible



MICRO HAWK

Barcode Readers



MICROSCAN®

1982
Company Founded

Products Sold
1 Million

100+
Technology Patents

Worldwide Offices
22

300+
Partners Worldwide

Microscan: Barcode Reading At Its Best

Microscan provides today's industrial professionals with the most user-friendly barcode reading platforms, thoughtfully engineered to meet tomorrow's challenges. Our barcode readers enable faster, more accessible, and broader data communication in a wide range of applications.

As the inventor of the first laser diode barcode scanner, our company was founded on technology innovation and continues to be a technology leader today. Microscan holds one of the world's most extensive patent portfolios for barcode reading technology, including laser scanning, imaging technologies, hardware, and software.

Microscan is in a continuous process of research and development to provide cutting-edge technology and complete solutions for auto ID barcode applications. Today, we provide fast, reliable reading solutions for all symbologies. Our products read any linear barcode or 2D symbol printed or marked by any means, with a versatility and ease-of-use unprecedented in the industry.

Microscan products are sold and supported through a global network of partners and systems integrators who specialize in automation solutions. The network includes more than 300 experienced automation integrators and value-added resellers in over 30 countries who provide highly-specialized local support.



MicroHAWK: Simply Incredible

Mini is now micro. Ease of use is now intuitive. Performance is now available in any configuration. Barcode reading is now simply incredible. Meet MicroHAWK, the next generation of industrial barcode readers. Built on the highest-performance imaging engine in its class, MicroHAWK barcode readers offer an array of modular hardware options to take on any decoding task in three micro form factors. No software to install, no compatibility obstacles, no experience needed. Just plug in and open a browser.



- World's smallest industrial barcode readers
- Read any code on any surface
- User-friendly barcode reading platform
- Customizable hardware options

Features	ID-20	ID-30	ID-40
1D Omnidirectional Barcodes	●	●	●
1D/2D Barcodes	●	●	●
Damaged Barcodes	●	●	●
Direct Part Mark (DPM)		●	●
Enclosure	IP40	IP54	IP65/67
Ethernet TCP/IP, EtherNet/IP™			●
Ethernet over USB	●	●	
Serial (RS-232)		●	●
USB 2.0 High Speed / HID	●	●	
Power over Ethernet (PoE)			●
Outer Illumination		●	●
Liquid Lens Autofocus		●	●
Standard or High-Density	●	●	●
Color Sensor	●	●	●
High-Speed		●	●
WebLink User Interface	●	●	●

MicroHAWK Engine



- Provides the full range of capabilities for all readers in the MicroHAWK family
- Smallest fully-integrated imaging engine available
- Lightweight, feature-rich, and ready for easy integration into a wide range of instruments and machines

Microscan's WebLink User Interface



- World's first web-based barcode reader interface
- No software to download or install
- Compatible with any USB or Ethernet MicroHAWK reader
- Set up, test, and control your reader from the browser of your choice



Incredibly Small

Designed specifically for integration into the tightest spaces, MicroHAWK barcode readers are the most compact, lightweight, and durable devices for tough industrial environments. The ID-40 is the world's smallest industrial IP65/67-rated barcode reader available. MicroHAWK readers include features such as integrated lighting and targeting LEDs, flexible cabling, omnidirectional reading, and adjustable read ranges from 50 to 300 mm (2 to 12 in.) or liquid lens autofocus to read codes at any variable range.



ID-40
SMALLEST
 Industrial IP65/67-Rated
 Barcode Reader Ever

MicroHAWK Readers Can Decode:

- Directly-printed barcodes on labels
- Directly-marked Data Matrix including dot peen, laser etch, and ink jet
- Low contrast, scratched, or poorly-printed barcodes
- Mix of 1D and 2D barcodes on a single part or package

Incredibly Powerful

When the ability to read challenging barcodes and marks is critical to success, count on MicroHAWK. Damaged and incomplete symbols are processed by X-Mode algorithms to render damaged symbols readable despite unpredictable print issues, scratches, or obstructions. For reliable decoding at the speed you need, MicroHAWK readers come standard with speeds up to 10 frames per second (FPS). High-Speed options are also available with speeds up to 60 FPS.

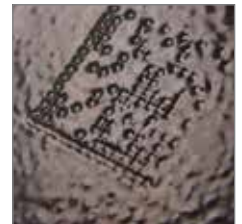

Incredibly Agile

MicroHAWK offers nearly endless configurations in three micro-form-factor barcode readers. Sensor, speed, lighting, focus, and decoding power can be selected in any combination and packaged into the MicroHAWK reader of your choice with ideal dimensions, connectivity, and industrial rating to meet your requirements. Tailor the performance of these readers to meet the exact requirements of your barcode reading application for optimal size, connectivity, and cost-efficiency. From omnidirectional decoding of 1D barcodes to tough, low-contrast 2D symbols, any MicroHAWK reader can be engineered with the exact features you need.



SENSOR:
WVGA, SXGA
or QSXGA



DECODER:
Standard, Plus,
or X-Mode



SPEED:
Standard or
High-Speed



LENS:
Standard or High-Density,
Fixed or Autofocus



LIGHTING:
Inner/Outer;
Red or White LEDs

Incredibly Intuitive

Experience is optional. MicroHAWK barcode readers are the easiest industrial devices to set up and install. Begin reading right out of the box within seconds. Just connect power to start decoding and open a browser to configure. Use a PC, laptop, tablet, or any device with a web browser to set up a reader and view decoded data and barcode images in real time using WebLink, Microscan's intuitive barcode reader interface. Make adjustments to reader settings without physical access to the reader itself. With the most intuitive controls of any barcode setup tool, WebLink finally brings the age of usability to industrial barcode reading.

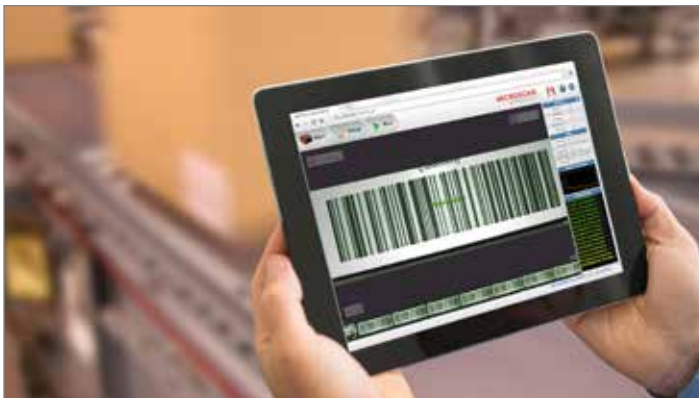

1500+

Possible
hardware/software
combinations
to solve
ANY
barcode
application

1



2



3





ID-20 OEM Barcode Reader

- Ultra-compact (19.5 mm x 28.7 mm x 33.9 mm)
- USB 2.0 High Speed, Ethernet over USB
- X-Mode advanced decoding algorithms
- Integrated targeting and read/pass indicators
- Programmable red or white LED illumination
- WebLink browser-based setup interface

AVAILABLE DECODERS

- Standard: High-contrast 1D barcodes
- Plus: High-contrast 1D/2D barcodes
- X-Mode: All 1D/2D, including damaged or poorly-printed barcodes

AVAILABLE ILLUMINATION

- Inner: 8 LEDs come standard; programmable red or white

The world's smallest full-featured and fully-integrated barcode imager, ID-20 offers OEMs and engineers a perfect set of value and performance options in a tiny, simple, and streamlined solution for embedded designs or WIP traceability.

ID-20, the only reader of its kind, offers a single-cable solution that uses USB for both communication (USB 2.0 High Speed and Ethernet over USB) and power to enable plug-and-play integration. Mini is now micro and incredibly easy to use.

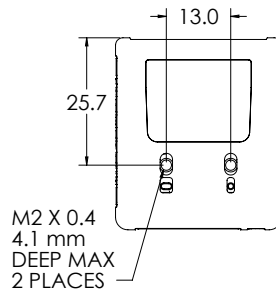
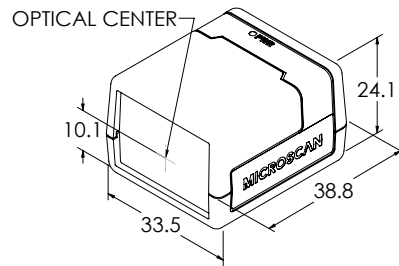

PIN ASSIGNMENTS Micro-B USB Socket

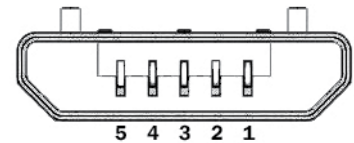

Pin	Function
1	Vbus (5V)
2	D-
3	D+
4	NC
5	Ground

APPLICATION EXAMPLES

- Life sciences and clinical instrumentation
- Laboratory automation and dispensing
- Electronics assembly and test
- Kiosk and ticketing



Note: Specifications are subject to change.

For complete technical information, please see the User Manual available at www.microscan.com.

ID-30 Miniature Barcode Reader

A micro-sized barcode imager with huge potential, the ID-30 furthers Microscan's 30+ year legacy of innovative, space-efficient, miniature design with a corner-exit cable and high-density 15-pin connector (offering serial, USB 2.0 High Speed, and Ethernet over USB capabilities) as well as optional liquid lens autofocus.

Perfect for OEMs and machine builders, the ID-30 offers the perfect combination of size, performance, and flexible integration. The ID-30 outperforms any reader in its class and is the ideal solution for automation engineers looking for incredible performance in a micro-sized product.

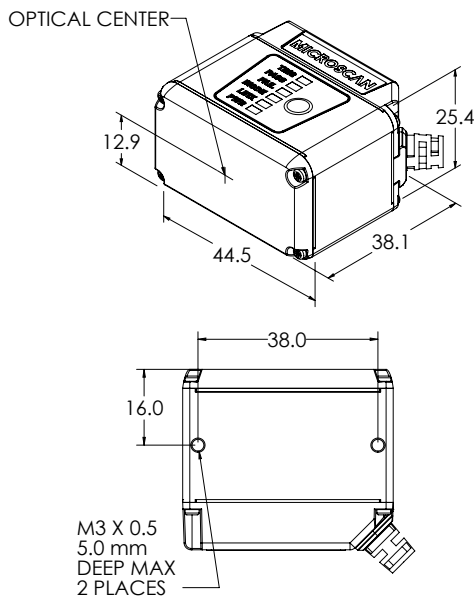

PIN ASSIGNMENTS High-Density 15-Pin Dsub Socket

Pin	Function
1	+5VDC
2	TX232
3	RX232
4	GND
5	D+
6	N/C
7	Output 1+
8	Default+
9	Trigger+
10	D-
11	Output 3+
12	New Master+
13	Reserved
14	Output 2+
15	Vbus

Note: Accessory cable required between 15-pin socket and host USB port.

APPLICATION EXAMPLES

- *Clinical instruments:*
 - Embedded barcode reading
 - Sample tracking and vial reading
- *Medical devices:*
 - Dot peen or laser marks on products
- *Electronics:*
 - Laser markings on PCBs
 - Sub-assembly tracking
- *Semiconductors:*
 - Laser marks on packages and components



- *Ultra-compact (44.5 mm x 38.1 mm x 25.4 mm)*
- *Serial, USB 2.0 High Speed, Ethernet over USB*
- *X-Mode advanced decoding algorithms*
- *Optional liquid lens autofocus*
- *Integrated targeting and read/pass indicators*
- *Programmable red or white LED illumination*
- *WebLink browser-based setup interface*

AVAILABLE DECODERS

- *Standard: High-contrast 1D barcodes*
- *Plus: High-contrast 1D/2D barcodes*
- *X-Mode: All 1D/2D, including low-contrast, damaged, or poorly-printed barcodes; Direct Part Marks (DPM)*

AVAILABLE ILLUMINATION

- *Inner: 8 LEDs come standard; programmable red or white*
- *Outer: 8 additional high-output LEDs are optional; available in red or white*

Note: Specifications are subject to change.

For complete technical information, please see the User Manual available at www.microscan.com.



- Ultra-compact (44.5 mm x 44.5 mm x 25.4 mm)
- High-speed Ethernet, serial (RS-232)
- X-Mode advanced decoding algorithms
- Optional liquid lens autofocus
- Power over Ethernet (PoE)
- Integrated targeting and read/pass indicators
- Programmable red or white LED illumination
- WebLink browser-based setup interface

AVAILABLE DECODERS

- Standard: High-contrast 1D barcodes
- Plus: High-contrast 1D/2D barcodes
- X-Mode: All 1D/2D, including low-contrast, damaged or poorly-printed barcodes; Direct Part Marks (DPM)

AVAILABLE ILLUMINATION

- Inner: 8 LEDs come standard; programmable red or white
- Outer: 8 additional high-output LEDs are optional; available in red or white

ID-40 Industrial Ethernet Barcode Reader

A revolutionary new product, the ID-40 redefines the imager market as the smallest IP65/67-rated, true-industrial Ethernet barcode reader. With best-in-class decoding for 1D/2D or DPM codes in a rugged, ultra-compact case, the ID-40 is the complete package for solving any barcode reading challenge under any condition.

Combining unprecedented ease-of-use, exceptional decode performance, optional liquid lens autofocus, and ultra-small form factor, the ID-40 sets the benchmark as the ultimate compact imager in the industry.

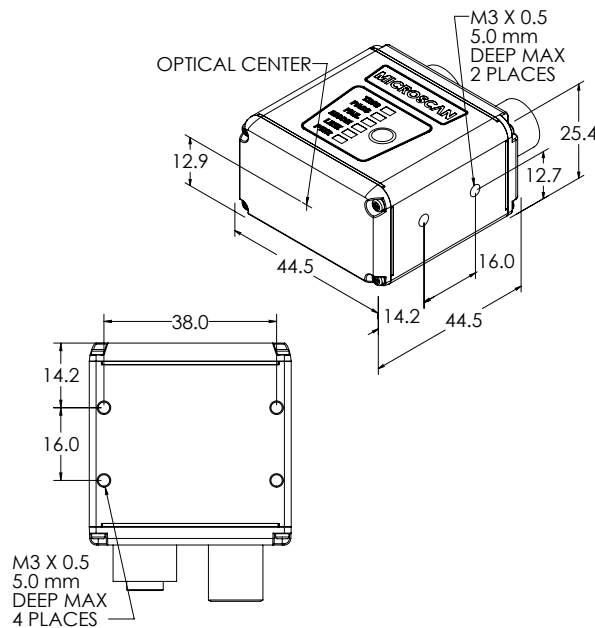

CONNECTOR A M12 12-pin plug:

Pin	Function
9	Host RxD
10	Host TxD
2	Power
7	Ground
1	Trigger
8	Input Common
3	Default
4	New Master
5	Output 1
11	Output 2
6	Output 3
12	Output Common

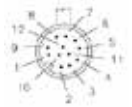

ETHERNET CONNECTOR B M12 8-pin socket:

Pin	Function
1	Reserved
2	Terminated
3	Reserved
4	TX (-)
5	RX (+)
6	TX (-)
7	Terminated
8	RX (-)



APPLICATION EXAMPLES

- Assembly line manufacturing
- Component tracking
- Automotive:
 - Dot peen on powertrain components
 - Laser marks on automotive electronics
- Medical devices:
 - Laser marks on components
- Electronics:
 - Laser markings on PCBs
- Semiconductors:
 - Laser marks on packages and components



Note: Specifications are subject to change.

For complete technical information, please see the User Manual available at www.microscan.com.

WebLink User Interface

Set up, test, control, and monitor your MicroHAWK reader from the web browser of your choice using Microscan's WebLink user interface. Simply enter your reader's IP address on any web-enabled device and follow an intuitive setup process to gain access to reader controls.

Decode single, multiple, static, moving, printed, or directly marked codes, and even train the interface to adjust for challenging lighting conditions and damage. With WebLink, you can access any MicroHAWK reader's settings in real-time without software or physical adjustment of the camera.

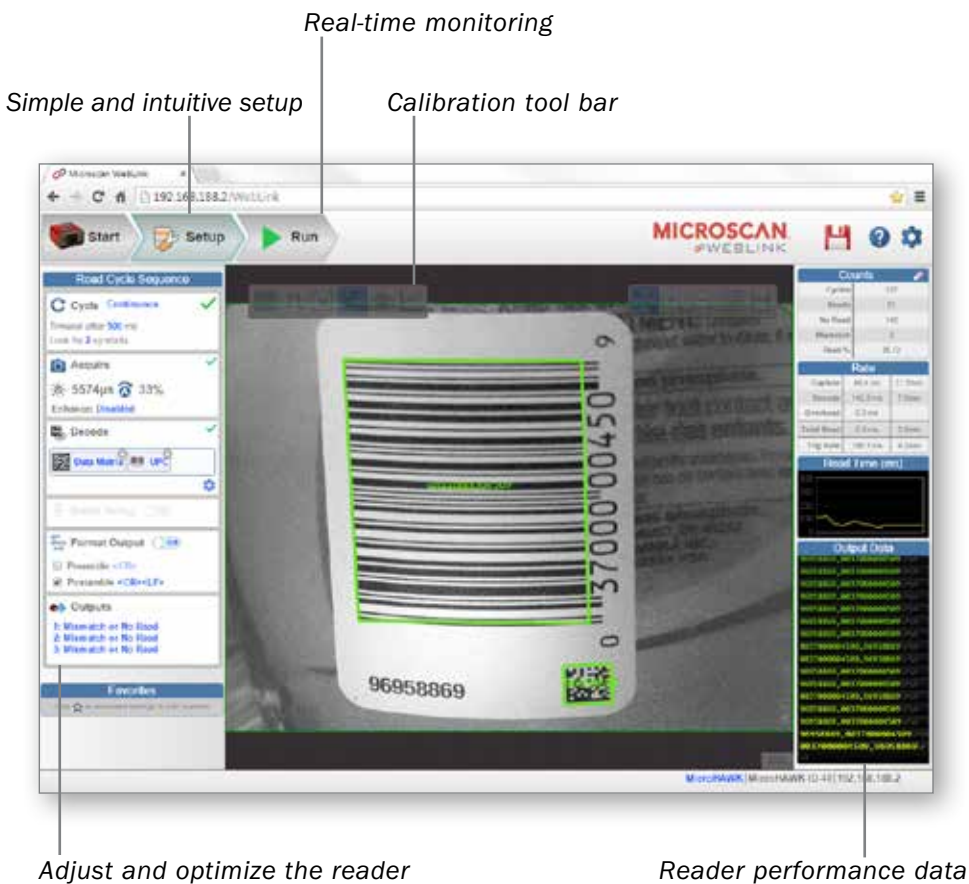

- World's first browser-based setup interface for industrial barcode reading
- No software to download or install
- One-click symbol training and optimization tools
- Best-in-class useability
- Real-time remote access to reader settings and results
- Automatic image storage from camera to external server
- Software Development Kit (SDK) for custom interfaces
- Common setup interface across all MicroHAWK readers

Superior Barcode Reading for Any Industry

Data accuracy and reliability are critical for modern manufacturers. MicroHAWK barcode readers offer the widest range of hardware options available to meet any industrial need, all within a miniature form factor that has virtually unlimited integration potential.

With no software to install, and no compatibility obstacles, MicroHAWK solves the toughest barcoding challenges for manufacturers in a diverse range of applications and industries around the world.



ELECTRONICS

- Component and PCB traceability
- Sub-assembly tracking
- Automated line changeover
- Quality assurance
- WIP tracking

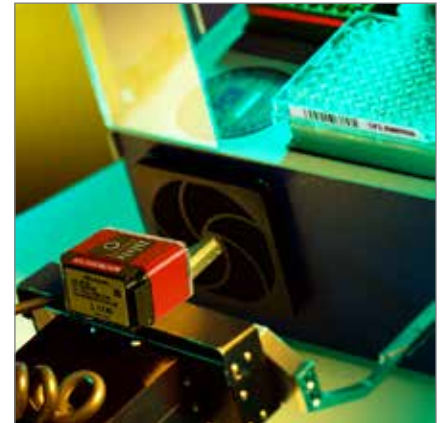

LIFE SCIENCES

- Sample tracking
- Medical device tracking
- Test level traceability
- Vial reading and verification



PACKAGING:

- Match inserts to packaging
- Item traceability
- Quality assurance
- Anti-counterfeiting measures
- Package sortation
- Carton coding
- Print and apply

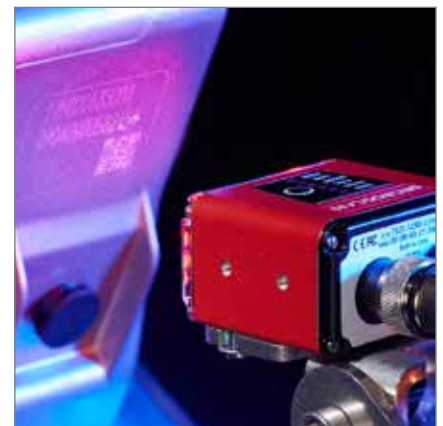

OTHER INDUSTRIES:

- Automotive
- Aerospace
- DoD and IUID
- Contract manufacturing
- Document handling
- Kiosks and self-service terminals

MicroHAWK Product Specifications

	ID-20			ID-30			ID-40		
DECODER	Standard (High-Contrast 1D)			Standard (High-Contrast 1D)			Standard (High-Contrast 1D)		
	Plus (High-Contrast 1D/2D)			Plus (High-Contrast 1D/2D)			Plus (High-Contrast 1D/2D)		
SPEED	X-Mode (Poor or Damaged 1D/2D)			X-Mode (Poor or Damaged 1D/2D + DPM)			X-Mode (Poor or Damaged 1D/2D + DPM)		
	Standard (up to 10 FPS)			Standard (up to 10 FPS) or High-Speed (max. sensor FPS)			Standard (up to 10 FPS) or High-Speed (max. sensor FPS)		
DENSITY	Standard or High-Density			Standard or High-Density			Standard or High-Density		
SENSOR (CMOS)	WVGA 0.34MP (752x480)	SXGA 1.2MP (1280x960)	QSXGA 5MP (2592x1944)	WVGA 0.34MP (752x480)	SXGA 1.2MP (1280x960)	QSXGA 5MP (2592x1944)	WVGA 0.34MP (752x480)	SXGA 1.2MP (1280x960)	QSXGA 5MP (2592x1944)
SHUTTER	Global		Rolling	Global		Rolling	Global		Rolling
FPS	60	42	5	60	42	5	60	42	5
EXPOSURE	50 - 100,000 Default: 2,500 μ s			50 - 100,000 Default: 2,500 μ s			50 - 100,000 Default: 2,500 μ s		
COLOR	QSXGA only			QSXGA only			QSXGA only		
FOCUS	Fixed (50-300 mm)			Fixed (50-300 mm) Liquid Lens Autofocus			Fixed (50-300 mm) Liquid Lens Autofocus		
CONNECTIVITY	USB 2.0 High Speed, Ethernet over USB / HID			RS-232, USB 2.0 High Speed, Ethernet over USB / HID			RS-232, Ethernet TCP/IP, EtherNet/IP, Power over Ethernet (PoE)		
CONNECTOR	Micro-B USB			High-Density 15-Pin D-Sub			M12 12-Pin Power, M12 8-Pin Ethernet		
CABLE	N/A			0.91 m			N/A		
ILLUMINATION	Inner LEDs: 4 White and 4 Red			Inner LEDs: 4 White and 4 Red			Inner LEDs: 4 White and 4 Red		
	Outer LEDs: N/A			Outer LEDs: 8 High-Output White or Red (Optional)			Outer LEDs: 8 High-Output White or Red (Optional)		
DISCRETE I/O	N/A			3 in/3 out Trigger Input: 5-28V rated (0.16mA @ 5VDC); New Master: 5 to 28V rated (0.16mA @ 5VDC); Default: 3.3V rated (0mA @ 3.3V) Outputs (1, 2, 3): 5V TTL-compa tible, can sink 10mA and source 10mA			3 in/3 out, Optoisolated Trigger Input; New Master: Bi-directional, opto-isolated, 4.5-28V rated (10mA @ 28VDC) Outputs (1, 2, 3): Bi-directional, opto- isolated, 1-28V rated (ICE < 100mA at 24VDC, current limited by user)		
ELECTRICAL	5 VDC \pm 5 %, 350 mA at 5 VDC (typ.)			5 VDC \pm 5 %, 600 mA at 5 VDC (typ.)			4.75-30 VDC, 200 mV p-p max ripple, 150 mA at 24 VDC (typ.)		
DIMENSIONS	24 mm x 34 mm x 39 mm			25 mm x 45 mm x 38 mm			25 mm x 45 mm x 45 mm		
WEIGHT	26 g			46 g (Excluding Cable)			68 g		
ENCLOSURE	IP40, Plastic			IP54, Aluminum			IP65/67, Aluminum		
INDICATORS	Target Pattern, Good Read Green Flash			Target Pattern, Good Read Green Flash, Performance LEDs			Target Pattern, Good Read Green Flash, Performance LEDs		

SYMBOLOGIES

2D Symbologies: Data Matrix (ECC 0-200), QR Code, Micro QR Code, Aztec Code **Stacked Symbologies:** PDF417, Micro PDF417, GS1 Databar (Composite & Stacked) **Linear Barcodes:** Code 39, Code 128, BC 412, I2 of 5, UPC/EAN, Codabar, Code 93, Pharmacode, PLANET, PostNet, Japanese Post, Australian Post, Royal Mail, Intelligent Mail, KIX

LIGHT SOURCE Type: High-output LEDs **Output Wavelength:** Inner Red: 625 nm nominal; Outer Red: 617 nm nominal **Operating Life:** 50,000 hours @ 25° C

ENVIRONMENTAL Operating Temp.: 0° to 40° C (32° to 104° F) **Storage Temp.:** -50° to 75° C (-58° to 167° F) **Humidity:** 5% to 95% (non-condensing)

EMISSIONS: EN 55022:2010 Class A Limits **SAFETY & QUALITY:** FCC, CE, RoHS Compliant **QMS Certification:** www.microscan.com/quality

Note: Specifications are subject to change. For complete technical information, please see the User Manual available at www.microscan.com.

MicroHAWK Product Specifications

WVGA Sensor Read Ranges

Focal Distance		WVGA HIGH DENSITY						WVGA STANDARD DENSITY					
		Field of View		Typical 2D Mil Size	Depth of Field (mm)		Min. 2D Mil Size	Field of View		Typical 2D Mil Size	Depth of Field (mm)		Min. 2D Mil Size
in.	mm	in.	mm	mil size	Inside	Outside	mil size	in.	mm	mil size	Inside	Outside	mil size
2.0	50	1.4	35	7.5	43	58	5	2.0	50	10	38	65	7.5
2.5	64	1.5	38	7.5	55	73	5	2.2	55	10	49	78	7.5
3.2	81	1.9	49	10	65	97	7.5	2.8	70	15	56	106	10
4.0	102	2.6	65	10	83	121	10	3.7	94	20	52	152	15
5.2	133	3.1	80	15	90	176	10	4.5	115	20	78	187	15
7.5	190	4.5	114	20	133	246	15	6.5	165	30	128	252	20
11.8	300	7.1	180	30	179	422	30	10.2	260	40	219	381	30

Example Read Range:

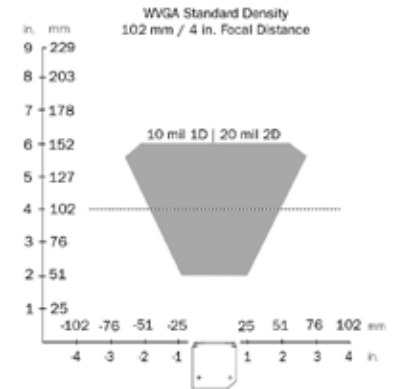

SXGA Sensor Read Ranges

Focal Distance		SXGA HIGH DENSITY						SXGA STANDARD DENSITY					
		Field of View		Typical 2D Mil Size	Depth of Field (mm)		Min. 2D Mil Size	Field of View		Typical 2D Mil Size	Depth of Field (mm)		Min. 2D Mil Size
in.	mm	in.	mm	mil size	Inside	Outside	mil size	in.	mm	mil size	Inside	Outside	mil size
2.0	50	1.5	37	5	47	55	3.3	2.1	53	7.5	37	64	5
2.5	64	1.6	41	5	58	70	3.3	2.3	59	7.5	49	78	5
3.2	81	2.0	52	7.5	70	92	5	2.9	75	7.5	60	102	7.5
4.0	102	2.7	69	7.5	88	116	5	3.9	100	10	74	131	7.5
5.2	133	3.4	85	10	107	159	7.5	4.8	123	10	88	161	10
7.5	190	4.8	122	15	137	243	10	6.9	175	15	115	265	15
11.8	300	7.6	192	20	185	400	15	10.9	277	20	224	427	20

Example Read Range:

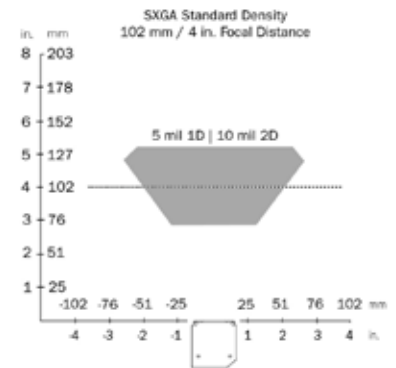

QXSGA (5MP) Sensor Read Ranges

Focal Distance		QXSGA HIGH DENSITY						QXSGA STANDARD DENSITY					
		Field of View		Typical 2D Mil Size	Depth of Field (mm)		Min. 2D Mil Size	Field of View		Typical 2D Mil Size	Depth of Field (mm)		Min. 2D Mil Size
in.	mm	in.	mm	mil size	Inside	Outside	mil size	in.	mm	mil size	Inside	Outside	mil size
2.0	50	1.4	35	5	46	55	3.3	2.0	51	5	43	59	3.3
2.5	64	1.5	39	5	59	68	3.3	2.2	57	5	55	72	3.3
3.2	81	2.0	50	5	74	87	3.3	2.8	72	5	69	92	5
4.0	102	2.6	66	5	94	110	3.3	3.8	96	7.5	80	124	5
5.2	133	3.2	81	7.5	112	153	5	4.6	117	7.5	107	159	7.5
7.5	190	4.6	116	10	154	227	7.5	6.6	168	10	150	231	10
11.8	300	7.2	184	15	227	373	10	10.4	265	15	203	397	15

Example Read Range:

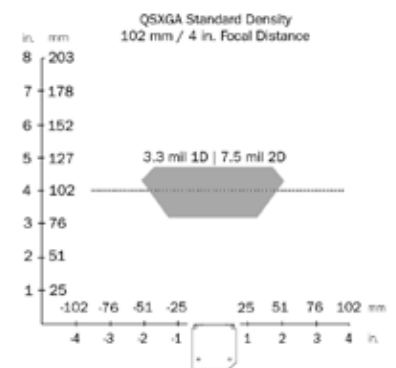

Note: Minimum 1D element is typically 1/2 size of minimum 2D element, (example: 10 mil 2D = 5 mil 1D).
Specifications are subject to change. For complete technical information, please see the User Manual available at www.microscan.com.

MICROSCAN
www.microscan.com

■ United States
Corporate Headquarters
700 SW 39th St.
Renton, WA 98057
(T) 425-226-5700/800-251-7711

■ European Headquarters
Lemelerberg 17
NL-2402 ZN Alphen aan den Rijn
The Netherlands
(T) 31-172-4233-60

■ Asia-Pacific Headquarters
31 Kaki Bukit Road 3 #05-08
TechLink, Singapore 417818
(T) 65-6846-1214